

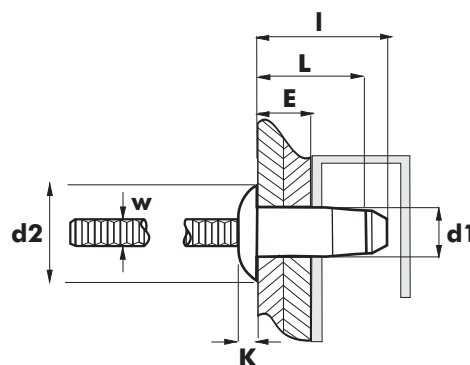

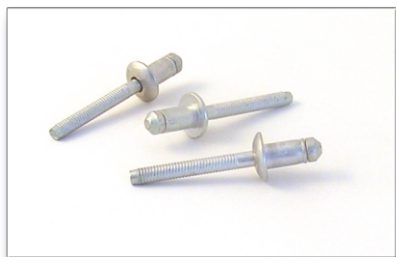

STEEL HARD LOCK DOME HEAD

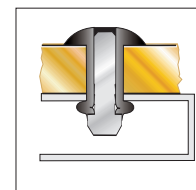
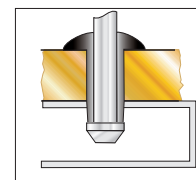

BODY: Steel Zinplated
MANDREL: Steel Zinplated

| d1 Ø m/m | L m/m | d2 Ø m/m | K m/m | W Ø m/m | M MÍN. m/m | I m/m |  MAX. E m/m |  | ART N. |
|----------------|-------------|----------------|----------|---------------|------------------|----------|---|---|---------------|
| 6,4 | 10,5 | 13,10 | 2,60 | 4,00 | | 15,0 | 2,8 - 4,8 | 6,70 - 6,90 | G1884 00 6410 |
| | 12,5 | | | | | 17,0 | 4,8 - 6,8 | G1884 00 6412 | |
| | 14,5 | | | | | 19,0 | 6,8 - 8,8 | G1884 00 6414 | |
| | 16,5 | | | | | 21,0 | 8,8 - 10,8 | G1884 00 6416 | |



| d1 Ø m/m | L m/m |  (N) |  (N) |
|----------------|-------------|---|---|
| 6,4 | 10,5 | 12.000 | 8800 |
| | 12,5 | 12.500 | 8800 |
| | 14,5 | 14.000 | 8800 |
| | 16,5 | 15.000 | 8800 |

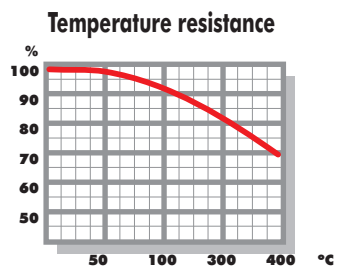

RAL