

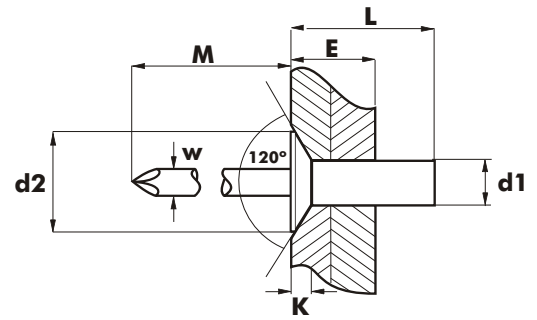

# ALUMINIUM SEALED COUNTERSUNK HEAD 120°

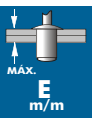



**BODY: Aluminium Al Mg 5**  
**MANDREL: Steel Lubricated**

UNE - EN ISO 15974

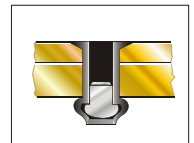
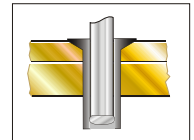
d1 Ø m/m	L m/m	d2 Ø m/m	K m/m	W Ø m/m	M MÍN. m/m	 E m/m		COD.
<b>4,8</b>	<b>10,0</b>	<b>9,50</b>	1,50	2,60	30,0	4,5 - 6,0	4,90	01112 00 4810
	<b>12,0</b>					6,0 - 8,0		01112 00 4812
	<b>14,5</b>					8,0 - 10,0		01112 00 4814
	<b>16,0</b>					10,0 - 12,0		01112 00 4816
	<b>22,0</b>					13,0 - 18,0		01112 00 4822

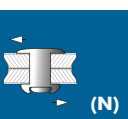

d1 Ø m/m	 (N)	 (N)
<b>4,8</b>	2.400	3.400

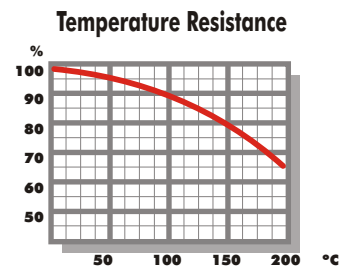

**RAL**