

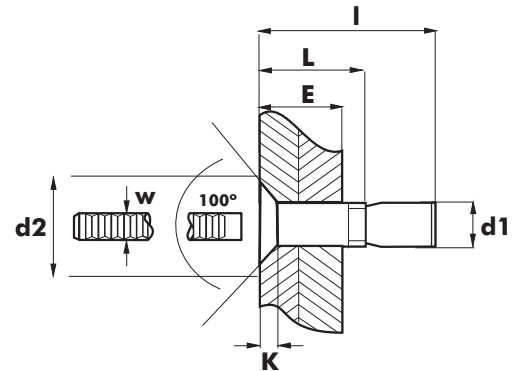

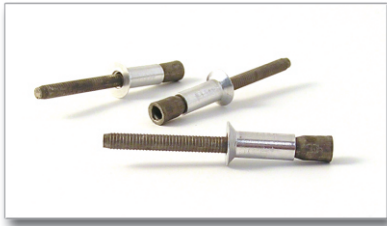

ALUMINIUM STRUCTURAL COUNTERSUNK HEAD 100°

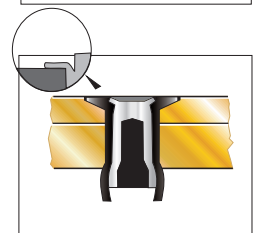
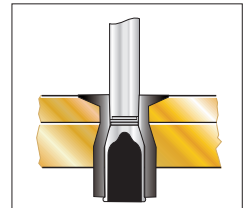
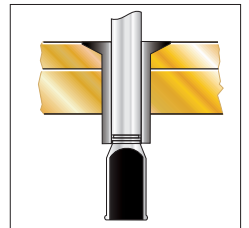

BODY: Aluminium Al Mg 5
MANDREL: Aluminium Al Mg

d1 Ø m/m	L m/m	d2 Ø m/m	K m/m	W Ø m/m	M MIN. m/m	I m/m	 MAX. E m/m		COD.
6,5	16	10,1	1,50	4,00	30,0	26,00	1,0 - 12,0	6,60-7,00	G1802 00 6516



d1 Ø m/m	 (N)	 (N)
6,5	6.000	4.200

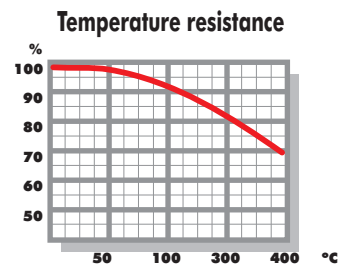

RAL