

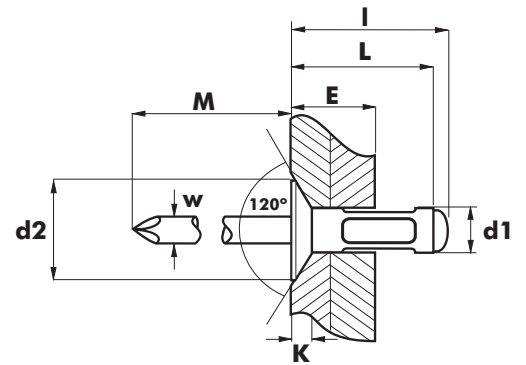

ALUMINIUM MULTIGRIP COUNTERSUNK HEAD 120°

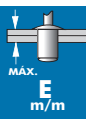



BODY: Aluminium Al Mg 2,5

MANDREL: Steel Zinplated

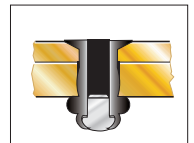
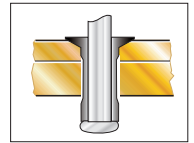
d1 Ø m/m	L m/m	d2 Ø m/m	K m/m	W Ø m/m	M MIN. m/m	I m/m	 MAX. E m/m		COD.
4,0	11,0	7,3	1,30	2,20	30,0	12,80	2,0 - 8,0	4,10 - 4,30	01090 00 4011
4,8	12,0 16,5	8,8	1,60	2,75	30,0	14,20 18,70	2,0 - 7,5 6,0 - 12,0	4,90 - 5,10	01090 00 4812 01090 00 4816



d1 Ø m/m	 (N)	 (N)
4,0	1.200	1.600
4,8	1.470	2.400

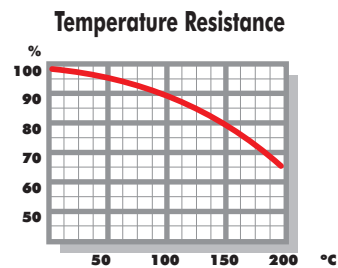

RAL 9005

More sizes 